

2538.162

DATE	REVISION DESCRIPTION	AUTH

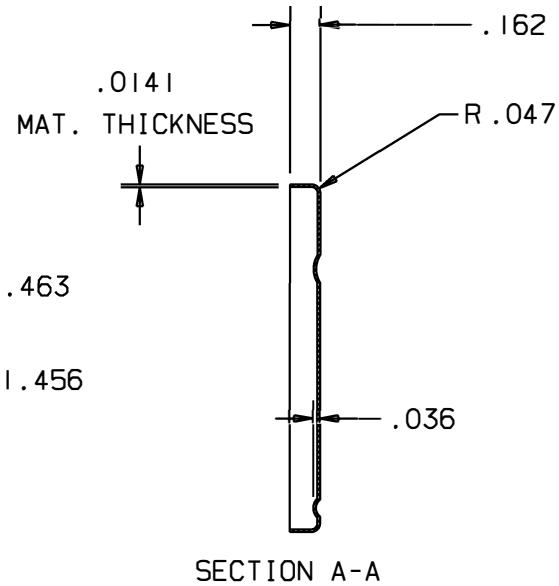
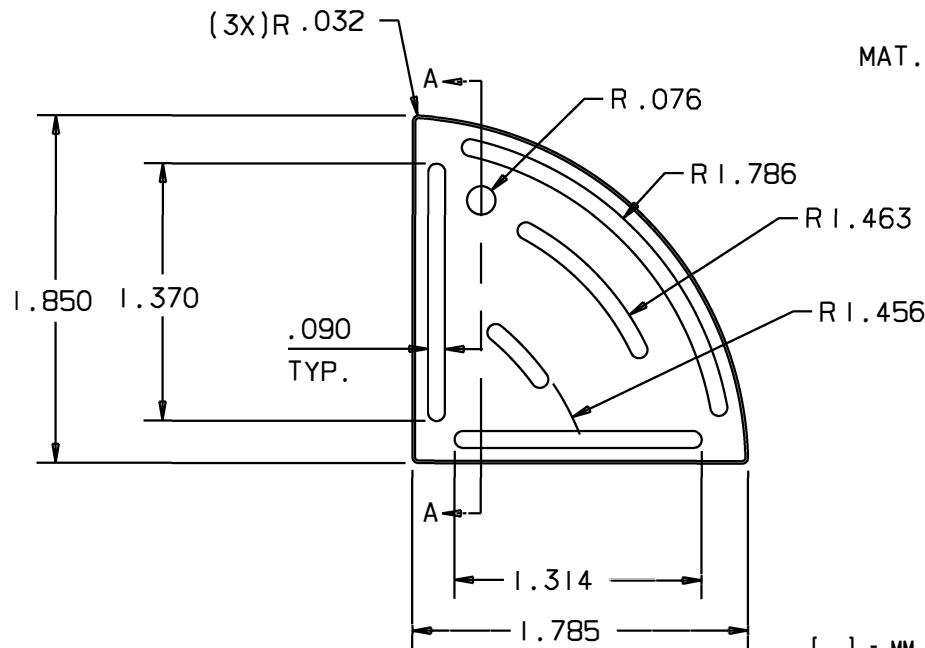

[] = MM

TOLERANCES	COSMETIC PAN		
INCH: ±.005 [±.13]	FELDWARE INC		
Radius: ±.010 [±.25]	DRAWN BY: D. Feldman	CODE:	
	DATE: APRIL ±8. 2024		
	MATERIAL: .0141" TINPLATE	SCALE: 1:1	TOOL NUMBER: 2538.162

THIS DOCUMENT CONTAINS CONFIDENTIAL AND PROPRIETARY INFORMATION THAT CANNOT BE REPRODUCED OR DIVULGED, IN WHOLE OR IN PART, WITHOUT WRITTEN AUTHORIZATION FROM FELDWARE INC